

turbofan[®]

Turbofan Convection Oven 30 Series

Use and Care Manual

E35T6
Electric Convection Oven
Touchscreen Control



249549-4
August 2025
Effective Lot No.: 2432000



Scan QR code* or visit
www.moffat.com.
*Requires reader to be installed on your
smartphone.

CONTENTS

Preface
 General information 3
 Safety information 3
 Warranty 4

Specifications
 Product information 5
 Overview 5
 Replacement parts 7

Operation
 Using the controls 8
 General operation 11
 Controller settings (Manager configuration mode) ... 20

Care and maintenance
 Maintenance schedule 24
 Maintenance tasks 25

Troubleshooting
 Fault finding 28
 Error codes 30

Appendix A: Controller ranges and defaults
 Manager configuration mode 32

THANK YOU

Thank you for purchasing this Turbofan oven. Your Turbofan oven is designed to provide years of reliable service.

This manual will provide you with the information you need to operate and maintain your oven in the best possible way. Please read this manual carefully and refer to it frequently.

This manual must be kept for the entire life of the oven. The manual must remain with the oven, even if the oven is transferred, sold, leased, or shared.

This manual must be stored carefully in the place where the oven is used so that it is readily available to operators for consultation.

For your records

Model number	_____
Serial number*	_____
Date of purchase	_____
Date installed	_____
Installer	_____

* Find the serial number on your oven's rating plate.

General information

The drawings and diagrams in this manual are representative only and not to scale. They supplement the written instructions and specifications that they refer to.

Copyright

❗ IMPORTANT

The reproduction or copying of any part of this manual by any means whatsoever is strictly forbidden unless authorised previously in writing by Moffat Limited.

Warranty requirements

❗ IMPORTANT

Installations must be carried out by a certified or licensed service person only. Failure to comply will void any written or implied warranty.

❗ IMPORTANT

Unauthorised alterations to the oven may void warranties and approvals.

Intended use and restrictions

❗ IMPORTANT

This appliance is intended for commercial use only, in kitchens of restaurants, canteens, and so on. It is not intended to be used in residential, outdoor, marine environments, or for the continuous mass-production of food.

- This oven must not be used by minors or adults with limited physical, sensory, or mental abilities.
- This oven must only be used by operators who are adequately trained in the purpose, limitations, and hazards of its operation. To avoid the risk of accidents or damage, operators should be regularly trained.

Product disposal



This symbol on the oven indicates that this oven should not be treated as domestic or regular commercial waste, but must be correctly disposed of in order to prevent any negative consequences for the environment and human health. For further information on the recycling of this oven, contact your local city office or your waste disposal service.

- ☑ The oven is built with common electrical, electromechanical, and electronic parts. No batteries are used.
- ☑ The owner and operator are responsible for the proper and safe disposal of the oven.

Safety information

Read the safety messages in this manual and follow the instructions carefully. Review them frequently.

Safety messages cannot cover every potential cause of injury or equipment damage but can highlight common causes of hazards. Read and understand all instructions in this manual prior to installing or servicing the oven and seek advice before operating the oven in a manner other than that described in this manual. Consult your authorised service technician before performing maintenance.

- Ensure that you and all operators of this appliance understand every safety message.
- Know and observe all safety rules that may apply to your work situation and your work site.
- Replace the user manuals and safety labels immediately if they are missing or damaged.

Recognize safety information



Safety alert symbol.

When you see this symbol in the manual or on the oven, pay special attention to the instructions.



Read the instructions before using the oven.



Risk of electric shock.



Risk of burns—hot surface.



Equipotential bonding terminal—must be connected to equipotential bonding system.



Risk of burns—hot liquid products above height level.

This manual uses the following safety symbols to indicate the level of caution required when using the oven.

Visit www.moffat.com for warranty terms and conditions or contact our Customer Care team.

⚠ DANGER

Indicates an imminently hazardous situation that, if not avoided, will result in death or serious injury.

⚠ WARNING

Indicates a potentially hazardous situation that, if not avoided, could result in death or serious injury.

⚠ CAUTION

Indicates a hazardous situation that, if not avoided, could result in minor or moderate injury.

NOTICE

Indicates information considered important, but not hazard-related (for example, messages relating to property damage).

General safety

⚠ WARNING

Improper installation, adjustment, alteration, service, or maintenance can cause property damage, injury, or death. Read the installation, operation, and maintenance instructions thoroughly before installing or servicing this oven.

⚠ DANGER

Fire hazard. Do not use gasoline or other flammable substances in the vicinity of this oven. Do not spray aerosols in the vicinity of this oven while it is in operation.

⚠ WARNING

Fire hazard. The oven operator shall take great care to use the oven safely and guard against risk of fire. The oven must not be left unattended during use.

NOTICE

The oven shall be regularly inspected by a competent service person to ensure that it is in safe and correct order for operation.

⚠ CAUTION

Do not operate this oven without the supplied legs fitted to it.

Warranty

Moffat warrants all equipment supplied by Moffat against defects in material and workmanship.

SPECIFICATIONS

Product information

	E35-26	E35-30
Capacity	6 shelves	6 shelves
Tray capacity	460 x 660 mm (18 x 26 inches) full-size sheet pan capacity	460 x 762 mm (18 x 30 inches) full size sheet pan capacity
Tray spacing	105 mm (4 1/8 inches)	105 mm (4 1/8 inches)
Net Weight	139 kg	158 kg

Overview

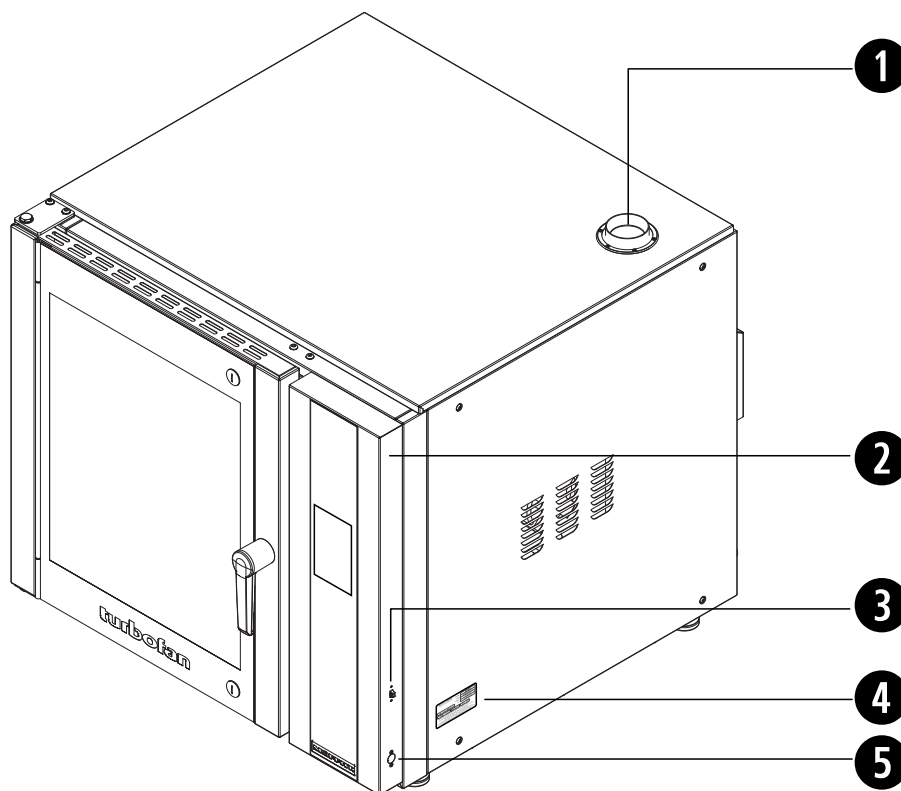

- 1 Vent
- 3 USB port
- 5 Core temperature probe port

- 2 Controller
- 4 Rating plate

Inside your oven

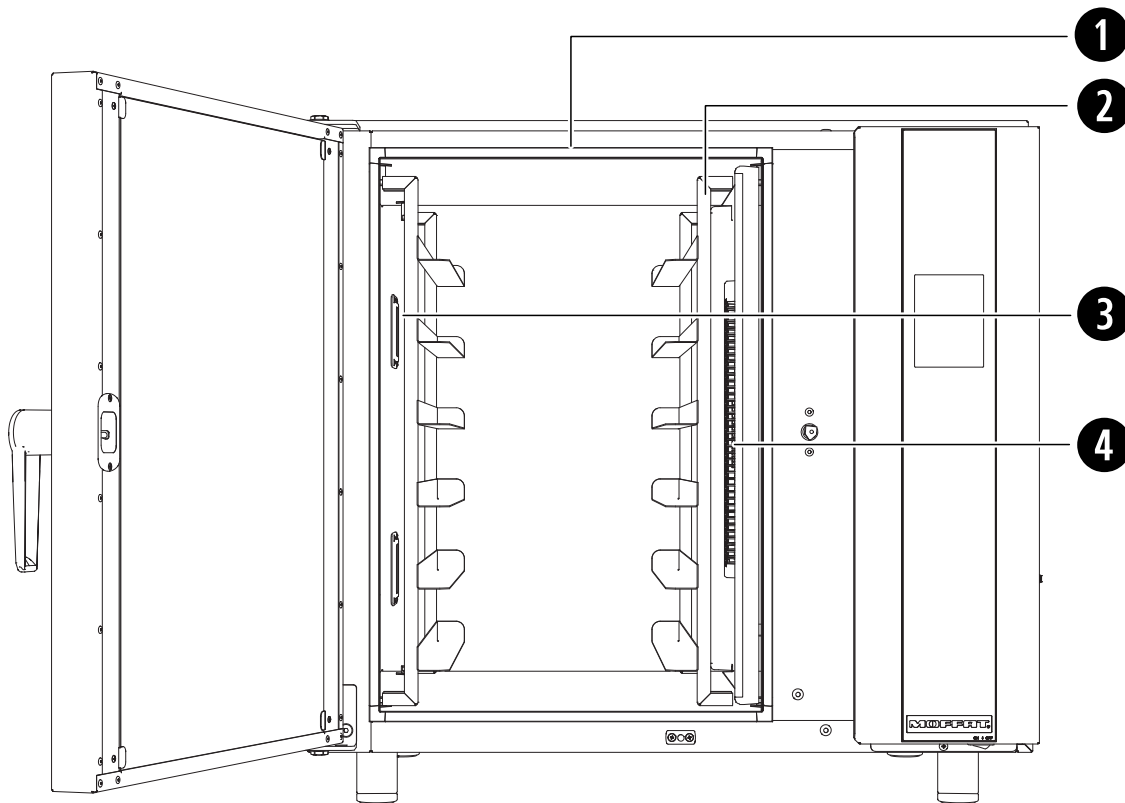

1 Door seal
3 Lamp

2 Side rack
4 Heating element

Replacement parts

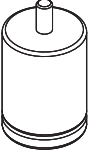
	Part No.	Description
	231438	Door Seal
	232379	Adjustable Leg 3 inches (76 mm)
	232380	Foot O-ring for Adjustable Leg

Lamp

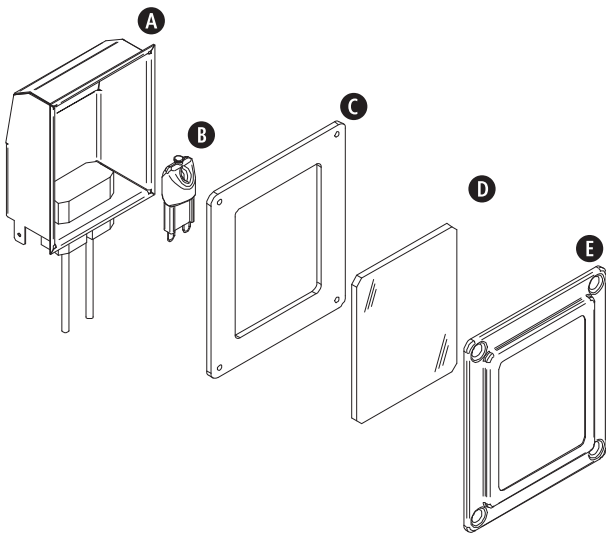

	Part No.	Description
A	236214	Lamp Holder (bulb Included)
B	231814	Lamp G9/25 W 230 V Halogen
C	242092	Gasket
D	021352	Glass Lens
E	021353	Support Frame

OPERATION

Using the controls

The following general indicators and operational controls appear on the control panel.



Turns control panel on or off.

This button is illuminated as follows:

- Red when the oven is powered-on but the control panel is off.
- Green when the control panel is on.



Turns the oven light on or off.



Cools the oven temperature to the Autocool temperature that is set. See [Controller settings \(Manager configuration mode\)](#) on page 20.



When illuminated blue in the bottom right-hand corner of the screen, indicates if the Moisture cooking mode is active.

☑ When the  is not illuminated, Moisture mode is selected but not in operation.



Indicates that the core temperature probe is connected.



Saves the change.



Discards the change.



Navigates to the previous screen.



Navigates to the next screen.



Starts the cooking cycle.



Stops the cooking cycle.



Pauses the cooking cycle.



Saves one or more settings.



HEAT OFF

Indicates if the oven is heating.
• A red dot appears above the HEAT ON indicator.



HEAT ON

BACK

Navigates to the previous screen.

HOME

Navigates to the main menu.

HELP

Shows the Help screen.

Operation modes

Mode	Description	Supported cooking modes
Manual	Adjust all aspects of the cooking process. See Cooking in Manual mode on page 12 . ⚡ Use Manual mode to cook products that you would only cook occasionally.	<ul style="list-style-type: none"> ● Convection ● Moisture ● With shelves ● Core temperature probe
Recipes	Cook to pre-set recipes. See Cooking with recipes (Recipes mode) on page 14 . ⚡ Use Recipes mode to cook one or more similar products automatically, according to programmed cooking settings. ⚡ Use Recipes mode to cook products that are cooked in one or more stages.	<ul style="list-style-type: none"> ● Convection ● Moisture ● With shelves ● Core temperature probe (when programmed in a recipe)

Cooking modes

Mode	Description
Convection	Cook products in a convection baking system. ⚡ Use Convection mode for roasting and browning products.
Moisture	Cook products in a convection baking system while periodically injecting small amounts of steam into the oven while cooking. ⚡ Use Moisture mode to prevent meats and pastries from drying out while cooking.
With shelves (Shelf mode)	Cook products in Convection or Moisture modes on different shelves for different amounts of time. ⚡ Use Shelf mode to cook different products that are cooked at the same temperature but require different cooking times.
Core temperature probe	Cook products in Convection or steam injection modes more accurately using a core temperature probe.

General operation

⚠ CAUTION
 Risk of burns. Parts of this oven will become very hot during operation and may cause burns if touched.

⚠ CAUTION
 Risk of burns. Always open the oven door with caution when the oven is hot and allow the hot air and steam to escape before handling items inside the oven.

Switching on the oven

1. Power-up the oven.
2. Turn on the switch on the bottom of the control panel.

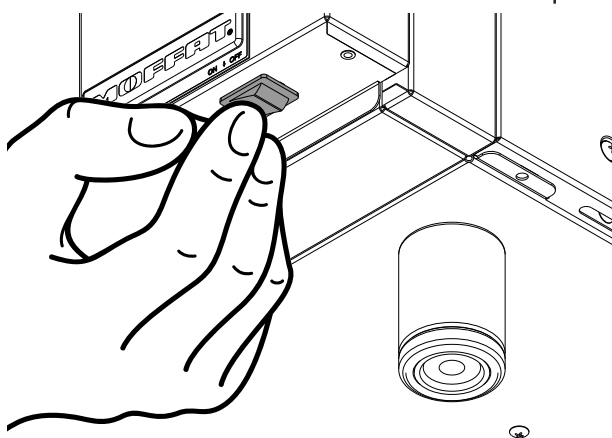

3. Press  on the screen to start using the oven. The main menu appears on the screen.

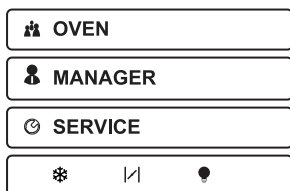

Cooking in Manual mode

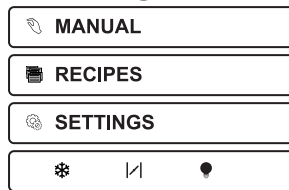

1. Press MANUAL to start cooking in manual mode.

- ☑ The oven preheats automatically until it reaches the set temperature.
- ☑ The  icon appears in the bottom left-hand corner of the screen when the oven is heating.

2. Set the Manual mode cooking parameters.

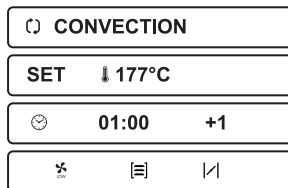

☑ Press the  button to switch to Steam mode.



- ☑ Press the number on the right-hand side of the Steam button to select the moisture level.
 - On the ENTER MOISTURE LEVEL screen, use the keypad to enter the moisture level required from 0-5.

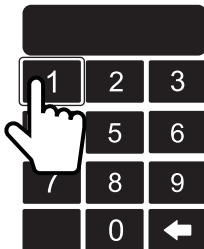

- Press ✓ to confirm.





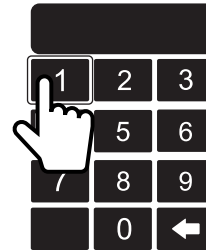

☑ The  icon appears in the bottom right-hand side of the screen when the oven is in Steam mode.

☑ Press the temperature value ( 177°C) on the SET button to set the cooking temperature.

- On the ENTER CAVITY SET TEMPERATURE screen, use the keypad to enter the cooking temperature from 50 °C-260 °C (120 °F-500 °F).
- Press ✓ to confirm.

- ☑ Press the time value (01:00) on the  button to set the cooking time.
 - On the ENTER COOK TIME screen, use the keypad to enter the cooking time from 00.01 seconds to 99.59 hours.



- Press ✓ to confirm.
 - ☑ Press  to toggle the fan speed between low and high.
 - Press ✓ to confirm.
 - ☑ Press  to use the oven with shelves. See [Cooking with the shelves \(Shelf mode\) on page 18](#).
 - ☑ Press  at the bottom of the screen to save your cooking parameters as the defaults.
3. (Optional) To use a core temperature probe for cooking, plug in the core temperature probe and insert the probe into the product. See [Cooking with the core temperature probe on page 19](#).
4. Place the product into the oven and close the door.
5. Press  to start cooking.
 - ☑ When using a core temperature probe, cooking starts immediately when the door is closed.
 - In Steam mode, press  to stop cooking.
 - In Convection mode, press  to pause cooking.

When cooking completes, an alarm sounds and the COOK COMPLETE screen appears.

- ☑ Press ✓ to continue cooking.
- ☑ Press +1 to continue cooking for one more minute.
- ☑ Press ✕ to stop the alarm.
- ☑ Open the oven door to stop cooking.
 - ☑ Open the oven door to cancel the alarm, turn off the fan, and stop the oven heating. Close the oven door again to resume cooking at the oven set temperature.

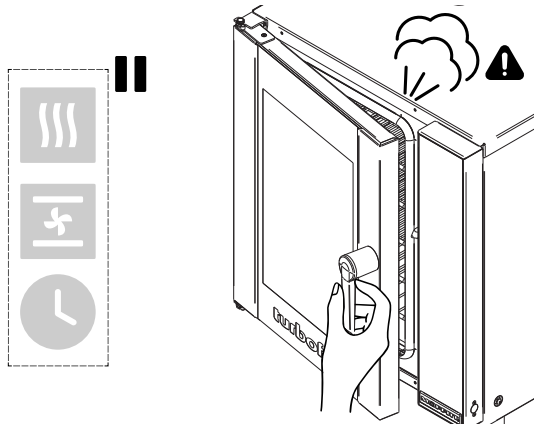

CAUTION
 Risk of burns. Always open the oven door with caution when the oven is hot and allow the hot air and steam to escape before handling items inside the oven.

- ☑ The oven continues heating while the oven door is closed.

Cooking in manual mode with the core probe

- ☞ Connect the core temperature probe to the oven. See [Cooking with the core temperature probe on page 19](#).
- ☑ The icon appears at the bottom of the screen when the core temperature probe is connected.
- ☞ Set the required cooking parameters as shown in the above section.

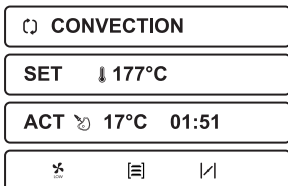

- ☞ Insert Core Temp probe into product and close the door. Cooking starts immediately when the door is closed.

Cooking completes when the product reaches the core probe set temperature. When cooking completes, an alarm sounds and the COOK COMPLETE screen appears.

- ☞ Press to continue cooking.
- ☞ Press **+1** to continue cooking for one more minute.
- ☞ Press **X** to stop the alarm.

- ☞ Open the oven door to stop cooking.
- ☞ Open the oven door to cancel the alarm, turn off the fan, and stop the oven heating. Close the oven door again to resume cooking at the oven set temperature.

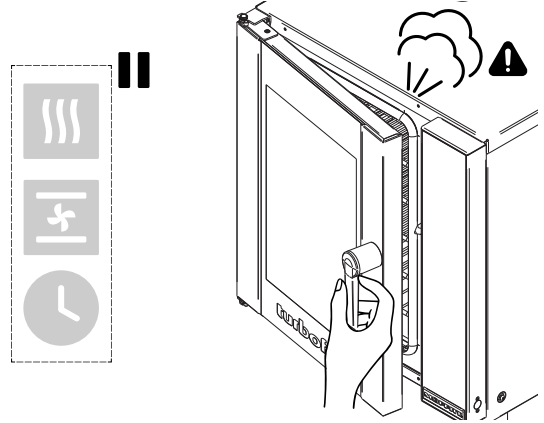

CAUTION
 Risk of burns. Always open the oven door with caution when the oven is hot and allow the hot air and steam to escape before handling items inside the oven.

- ☑ The oven continues heating while the oven door is closed.

Cooking with recipes (Recipes mode)

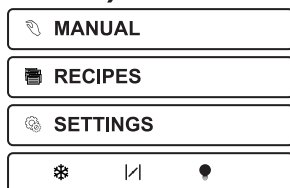

- Press RECIPES to start cooking in Recipes mode.
 - The oven preheats automatically until it reaches the set temperature.
 - The icon appears in the bottom left-hand corner of the screen when the oven is heating.
- On the SELECT PRODUCT screen, select the recipe from the list.

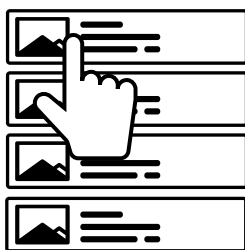

- Drag your finger across the screen or press at the bottom of the screen to scroll through the list.
- Press at the bottom of the screen to select the product category.
- Press at the bottom of the screen to edit the recipe. See [Saving and editing recipes on page 16](#).
- Press at the bottom of the screen to return to the main screen.

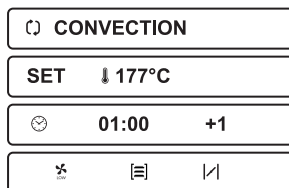

- Press and hold the SET button to view the actual temperature (ACT) of the oven cavity.

- (Optional) If the recipe selected has Core Probe programmed as part of recipe, plug in the core temperature probe and insert the probe into the product. See [Cooking with the core temperature probe on page 19](#).
 - If the recipe requires a core temperature probe, the PLUG IN CORE PROBE icon appears at the bottom of the recipe selected.

- If the recipe requires a core temperature probe, cooking starts immediately when you load the product into the oven and close the door.

- (Optional) To use shelves, press the icon on the main screen to set the shelf mode options. See [Cooking with the shelves \(Shelf mode\) on page 18](#).
- Place the product into the oven and close the door.
- Press to start cooking.
 - In Steam mode, press to stop cooking.
 - In Convection mode, press to pause cooking.

When cooking completes, an alarm sounds and the COOK COMPLETE screen appears, select from the following actions.

- Press to continue cooking.
- Press +1 to continue cooking for one more minute.
- Press to stop the alarm.

Recipes mode adjustments and controls

While a recipe is running you can view additional information and make adjustments to the settings.

- Adjustments are not saved to the recipe and are applied to the current stage only. Any following stages run according to the program settings.

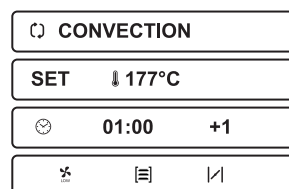



- Press the button to switch to Steam mode.

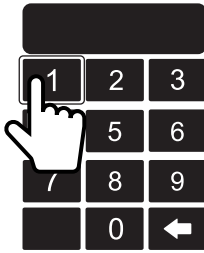

- Press the number on the right-hand side of the Steam button to select the moisture level.
 - On the ENTER MOISTURE LEVEL screen, use the keypad to enter the moisture level required from 0-5.





- Press ✓ to confirm.

- ☑ The  icon appears in the bottom right-hand side of the screen when the oven is in Steam mode.
- ☑ Press the temperature value ( 177°C) on the SET button to set the cooking temperature.

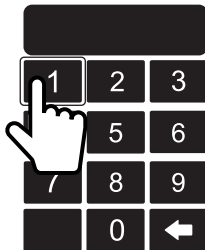

SET  177°C

- On the ENTER CAVITY SET TEMPERATURE screen, use the keypad to enter the cooking temperature from 50 °C-260 °C (120 °F-500 °F).



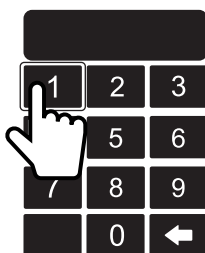

- Press ✓ to confirm.
- ☑ Press the time value (01:00) on the  button to set the cooking time.
- On the ENTER COOK TIME screen, use the keypad to enter the cooking time from 00.01 seconds to 99.59 hours.



- Press ✓ to confirm.
- ☑ Press  to toggle the fan speed between low and high.
- Press ✓ to confirm.
- ☑ Press  to use the oven with shelves. See [Cooking with the shelves \(Shelf mode\) on page 18](#).
- ☑ Press  at the bottom of the screen to save your cooking parameters as the defaults.

Saving and editing recipes

Access Recipes Edit mode



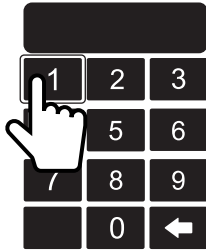

1. In the main menu, press **RECIPES** to access the Recipes mode options.
2. Press  at the bottom of the screen to enter Recipes Edit mode.
3. Use the keypad to enter the pass code and confirm  it.

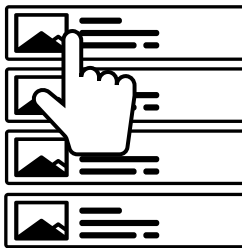

 The Recipe Edit mode pass code is 4500.

4. Select a recipe to edit using one of the following methods.
 - Select a recipe from the list.



-  Drag your finger across the screen or press  to scroll through the list.
-  Press **ALL** to select a recipe from the Product Category list.
-  Press **+** to create a new recipe.
-  Press **-** to delete the selected recipe.



Edit recipe (Edit Recipe screen)

NAME: PRODUCT
NAME

IMAGE: 

SELECT CATEGORIES





Use the screen controls to edit recipe data as follows:

-  Press **NAME** and use the keypad to enter and confirm  the recipe name.

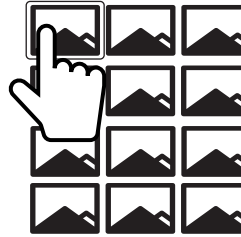



-  Press **IMAGE** to select the recipe image.









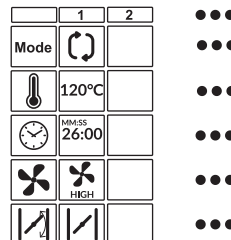





-  Press **SELECT CATEGORIES** to select the recipe categories.
 - Select a category from the list and press  to confirm your selection; press  to cancel your selection.
 -  Press **+** to add a new category.
 -  Press **-** to delete a selected category.

Edit recipe stages

-  Press  at the bottom of the EDIT RECIPE screen to edit the recipe's stages.



-  Press **+** to add a new stage.
-  Press **-** to delete a selected stage.
-  Press the **Mode** area for a stage to toggle between  CONVECTION or  MOISTURE mode.
-  Press the  area to set the cooking temperature for the stage.
-  Press the  area to set the cooking time for the stage.
-  Press the  area to toggle the fan speed for the stage.
-  Press the  area to toggle the vent state for the stage.

Exit Recipes Edit mode

Press **HOME** at the top of the screen to exit Recipes Edit mode and return to the main screen.

Cooking with the shelves (Shelf mode)

Use the oven in Shelf mode to cook different products that are cooked at the same temperature but require different cooking times. Shelf mode can be used in Manual or Recipes mode.

You cannot use Shelf mode with the core temperature probe.

1. Press **[≡]** to access Shelf mode options.
2. Select and configure one or more shelves for cooking.



- In Manual mode, press **+** to manually set the cooking time for the shelf or press **---** to set a timer for the shelf using the keypad.
- In Recipes mode, press **+** to select a recipe for the shelf or press **---** to set a timer for the shelf using the keypad.

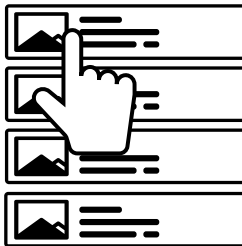

- 💡 When you click **+**, the SELECT PRODUCT screen shows recipes with the same cooking temperature.
- If you select a multi-stage recipe for a shelf, the other shelves can only be set to timers.

3. Load the shelves and close the oven door.



4. Press **▶** to start each shelf.
 - 👉 Press **■** to cancel the program for each shelf.
 - When a shelf is started, the information displayed for the shelf alternates between the cooking time left and the shelf setting—either Timer, Manual, or recipe name.

↓
5. When the shelf has completed its cooking cycle, open the door and remove the product from the shelf.
 - An alarm sounds when the cooking time for each shelf completes. Press **✓** or **+1** to continue cooking; press **✕** to cancel the alarm.
6. Close the door to resume cooking for the remaining shelves.

Cooking with the core temperature probe

An optional core temperature probe kit is available for this oven. See the Installation manual for more information.

The core temperature probe provides greater precision while cooking. Core temperature probe cooking is ideal for large items of food and has the following advantages.

- Improves control over the cooking process, eliminating the risk of loss and waste.
- Accurately cooks food, irrespective of the quality or quantity being cooked.
- Saves time because cooking control is automatic.
- Guarantees strict hygiene because, with precision monitoring of the core temperature, there is no need for food to be handled, poked, or pierced.

Connect the core temperature probe to the core temperature probe port on the side of the oven and insert it into the product on the shelf.

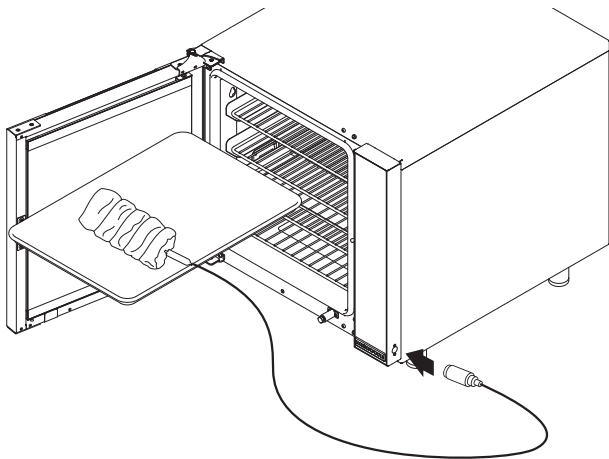

SET ↓ 148°C

ACT ↻ 19°C 00:57

When you connect the core temperature probe:

- The core probe icon appears at the bottom of the screen.
- The ACT (core probe temperature) option appears on the screen.

Select the core probe temperature as follows:

1. Press 19°C 00:57.
2. Use the keypad to set the core probe temperature required.
3. Press ✓ to save the setting; press ✕ to discard the setting.

When cooking with the core temperature probe:

- 19°C 00:57 shows the temperature reading from the core temperature probe along with the cooking time elapsed.
- Press and hold 19°C 00:57 to show the core probe set temperature.

SET ↻ 121°C

Best practices for core probe cooking

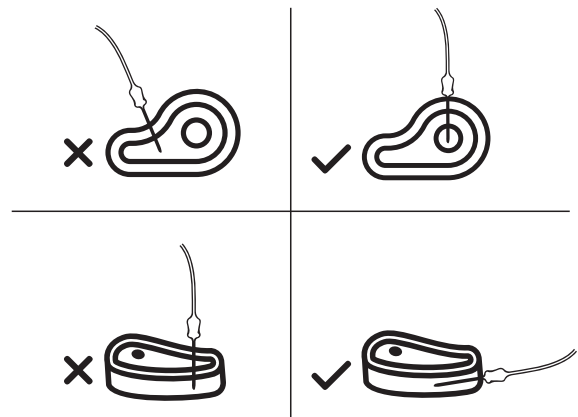

- Position the core temperature probe in the very centre of the food.
- Always insert the core temperature probe from the top downwards and into the centre of the food to be cooked.
- For products of thickness less than twice the probe length, insert the core temperature probe horizontal to the table top so that the tip of the core temperature probe reaches the middle of the food.
- Place food in the centre of the oven.

Controller settings (Manager configuration mode)

1. In the main menu, press SETTINGS to access the SETTINGS screen.

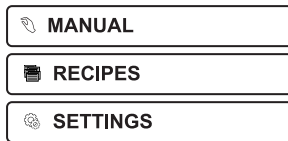

2. Press MANAGER to access the Manager settings.

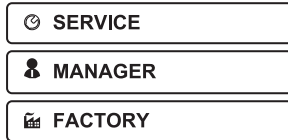

3. On the ENTER MANAGER PASSCODE, use the keypad to enter the passcode.

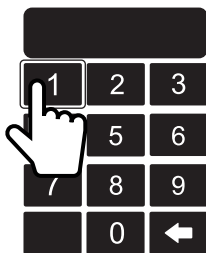

The Manager settings pass code is 4500.

▪ Press to confirm.

Manager settings

Access the required parameter setting as shown in the table below. Set the parameter according to the ranges specified for the controller. See [Appendix A: Controller ranges and defaults](#).

Press to display the next settings screen.





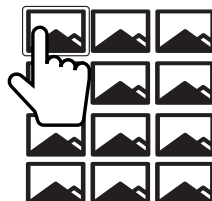































Press to display the previous settings screen.

Screen	Options	Description
1	<ul style="list-style-type: none"> MANUAL MODE COPY RECIPES TO USB COPY RECIPES FROM USB RECIPE IMAGE MAINTENANCE 	<ul style="list-style-type: none"> Press MANUAL MODE to enable or disable Manual mode in the main menu. Press COPY RECIPES TO USB to save your recipes to a USB drive that you have inserted into the control panel's USB port. Press COPY RECIPES FROM USB to copy saved recipes from a USB drive that you have inserted into the control panel's USB port. Press RECIPE IMAGE MAINTENANCE to manage recipe images stored in the controller. Press COPY IMAGES FROM USB to copy images from a USB drive that you have inserted into the control panel's USB port. <ul style="list-style-type: none"> Ensure that your recipe images are in .BMP format. Ensure that your USB drive is in the FAT32 file system format. Press DELETE RECIPE IMAGES to delete an image that you have selected on the screen.



Press SELECT ALL to select all the images for deletion.

Screen	Options	Description
2	<div data-bbox="280 300 568 344">🔊 BUZZER VOLUME</div> <div data-bbox="280 349 568 394">🔊 COOK DONE BEEP</div> <div data-bbox="280 398 568 443">🔊 READY BEEP</div> <div data-bbox="280 448 568 488">🔊 KEYPRESS FEEDBACK</div>	<ul style="list-style-type: none"> 👉 Press BUZZER VOLUME to cycle through and select the buzzer volume level (0-5). 👉 Press COOK DONE BEEP to toggle the control panel's beep when cooking completes. 👉 Press READY BEEP to toggle the control panel's beep when pre-heating completes. 👉 Press KEYPRESS FEEDBACK to toggle the control panel's beep when a button is pressed.
3	<div data-bbox="280 658 568 703">⏸ PREHEAT OPTIONS</div> <div data-bbox="280 707 568 775">📖 AUTOSTART OPTIONS</div> <div data-bbox="280 779 568 846">📖 SETBACK OPTIONS</div> <div data-bbox="280 851 568 922">❄ AUTOCOOL TEMPERATURE</div>	<ul style="list-style-type: none"> 👉 Press PREHEAT OPTIONS to configure the pre-heating settings for Recipes mode. <ul style="list-style-type: none"> <li data-bbox="667 721 954 788">📖 USE PREHEAT RECIPE <li data-bbox="667 792 954 837">🔊 FAN SETTINGS <li data-bbox="667 842 954 887">🌡 177°C 👉 Press USE PREHEAT RECIPE to toggle pre-settings for recipes on or off. 👉 Press FAN SETTINGS to toggle between high and low speed fan speeds. 👉 Press 🌡 to set the pre-heat temperature. 👉 Press AUTOSTART OPTIONS to configure auto-start mode options. <ul style="list-style-type: none"> <li data-bbox="667 1034 954 1079">📖 AUTO START <li data-bbox="667 1084 954 1128">🕒 07:20 AM <li data-bbox="667 1133 954 1178">🌡 177°C 👉 Press AUTO START to toggle auto-start on or off. 👉 Press 🕒 to set the time at which the oven is automatically started. <ul style="list-style-type: none"> 👉 Press AM (or PM) on the button to toggle between AM or PM time periods. 👉 Press 🌡 to set the auto-start temperature. 👉 Press SETBACK OPTIONS to configure the Setback mode options. <ul style="list-style-type: none"> <li data-bbox="667 1379 954 1424">📖 SETBACK MODE <li data-bbox="667 1429 954 1473">🕒 30:00 <li data-bbox="667 1478 954 1523">🌡 177°C 👉 Press 🕒 to set the Setback interval. 👉 Press 🌡 (or 🌀) to toggle between convection and moisture modes. <ul style="list-style-type: none"> 👉 Press the temperature displayed to the right of this button to set the Setback temperature. 👉 Press AUTOCOOL TEMPERATURE to set the temperature that the oven cools to when the ❄ button is pressed.

Screen	Options	Description
4	<div style="border: 1px solid black; padding: 2px; margin-bottom: 2px;">  COOK COOLDOWN </div> <div style="border: 1px solid black; padding: 2px; margin-bottom: 2px;">  RECIPE RUNTIME CHANGES </div> <div style="border: 1px solid black; padding: 2px; margin-bottom: 2px;">  SAVE MANUAL RUNTIME CHANGES </div> <div style="border: 1px solid black; padding: 2px;">  SAVE RECIPE RUNTIME CHANGES </div>	<ul style="list-style-type: none">  Press COOK COOLDOWN to enable or disable automatic oven cooling when the actual oven temperature is higher than the recipe's set temperature in Recipe Mode. <ul style="list-style-type: none"> <input checked="" type="checkbox"/> If COOK COOLDOWN is disabled, cooking starts for a recipe even if the actual oven temperature is higher than the recipe's set temperature.  Press RECIPE RUNTIME CHANGES to enable or disable recipe settings to be changed while cooking in Recipe mode.  Press SAVE MANUAL RUNTIME CHANGES to enable or disable settings to be saved while cooking in Manual mode. <ul style="list-style-type: none"> <input checked="" type="checkbox"/> When enabled, the save prompt  is displayed when settings are changed.  Press SAVE RECIPE RUNTIME CHANGES to enable or disable changes made to a recipe while cooking in Recipe mode to be saved. <ul style="list-style-type: none"> <input checked="" type="checkbox"/> When enabled, the save prompt  is displayed when settings are changed. <input checked="" type="checkbox"/> When enabled, changes saved during cooking will overwrite the original recipe.
5	<div style="border: 1px solid black; padding: 2px; margin-bottom: 2px;">  10:01:33 AM </div> <div style="border: 1px solid black; padding: 2px; margin-bottom: 2px;">  30/04/2023 </div> <div style="border: 1px solid black; padding: 2px; margin-bottom: 2px;">  LANGUAGE </div> <div style="border: 1px solid black; padding: 2px;">  TEMPERATURE UNITS </div>	<ul style="list-style-type: none">  Press  to set the current time in your location. <ul style="list-style-type: none">  Press AM (or PM) on the button to toggle between AM or PM time periods.  Press  to set the current date in your location. <ul style="list-style-type: none">  Press within the number field to edit its value using the keypad.  Press LANGUAGE to set your regional language. <ul style="list-style-type: none">  Press to select a language from the list.  Press TEMPERATURE UNITS to toggle between °C and °F units of temperature.
6	<div style="border: 1px solid black; padding: 2px; margin-bottom: 2px;">  BRIGHTNESS </div> <div style="border: 1px solid black; padding: 2px; margin-bottom: 2px;">  AUTO DIM </div> <div style="border: 1px solid black; padding: 2px; margin-bottom: 2px;">  PASSCODE MAINTENANCE </div> <div style="border: 1px solid black; padding: 2px;">  RE-CALIBRATE TOUCHSCREEN </div>	<ul style="list-style-type: none">  Press BRIGHTNESS to set the screen brightness level (0-5).  Press AUTO DIM to automatically dim the controller screen. Set the following options: <ul style="list-style-type: none"> <input type="checkbox"/> Time - the time in minutes after which the controller screen will reduce in brightness. <input type="checkbox"/> Brightness - the amount by which the controller screen brightness will reduce after time above has elapsed.  Press PASSCODE MAINTENANCE to manage access to restrictions. <div style="border: 1px solid black; padding: 2px; margin: 5px 0;">  RECIPE PASSCODE </div> <div style="border: 1px solid black; padding: 2px; margin: 5px 0;">  CHANGE RECIPE PASSCODE </div> <div style="border: 1px solid black; padding: 2px; margin: 5px 0;">  MANAGE PASSCODE </div> <div style="border: 1px solid black; padding: 2px;">  CHANGE MANAGER PASSCODE </div> <ul style="list-style-type: none">  Press RECIPE PASSCODE to enable or disable the pass code restriction for recipe editing. <ul style="list-style-type: none"> <input checked="" type="checkbox"/> The recipe pass code is the code that is set or the default factory setting (4500).  Press CHANGE RECIPE PASSCODE to set a new pass code for recipe editing using the keypad.  Press MANAGER PASSCODE to enable or disable the pass code restriction for accessing Manager mode.

Screen	Options	Description
		<ul style="list-style-type: none">☑ The Manager mode pass code is the code that is set or the default factory setting (4500).☛ Press CHANGE MANAGER PASSCODE to set a new pass code for accessing Manager mode.☑ The Manager mode pass code is the code that is set or the default factory setting (4500).

CARE AND MAINTENANCE

To achieve the best results, clean your oven regularly and thoroughly. If small faults occur, have them attended to promptly. Don't wait until they cause a complete breakdown.

⚠ CAUTION

Always turn off the electrical power at the mains supply before cleaning the oven.

⚠ WARNING

Do not use flammable solvents and cleaning aids on or in close proximity to, the oven when the oven is still hot.

NOTICE

- This oven is not water proof. Do not use water jet spray or steam cleaner to clean interior or exterior of the oven.
- Carefully read and follow the safety instructions on the label of the cleaning product to be used.
- Do not use cleaning products with an acidic base or those containing chlorine.
- Do not use saline or sulphuric acid preparations to descale the oven.
- Do not use sharp scrapers or harsh abrasive scourers as they could damage the oven.
- Immediately clean alkaline spills (such as salty liquids) or acidic spills (such as lemon juice or vinegar) from cooking surfaces or enamel.
- Ensure that any detergent or cleaning material has been completely removed after each cleaning.

Maintenance schedule

	Daily	Weekly	Periodic
Clean the interior including the door.	✓*	-	-
Clean the stainless steel surfaces.	-	✓	-
Clean the outer body, door seal, and inside of door.	✓†	-	-
Check and adjust controls and mechanical parts.	-	-	Every 6 months
☒ To be conducted by an authorized service technician only. Full product service.	-	-	Every 6 months

☒ To be conducted by an authorized service technician only.
 * For a heavy cooking schedule, perform this task after each shift.
 † For a heavy cooking schedule, perform this task daily.

Maintenance tasks

Cleaning the outer body

Clean the exterior stainless steel surfaces with a soft-bristle brush or a damp cloth moistened with a mild detergent solution.

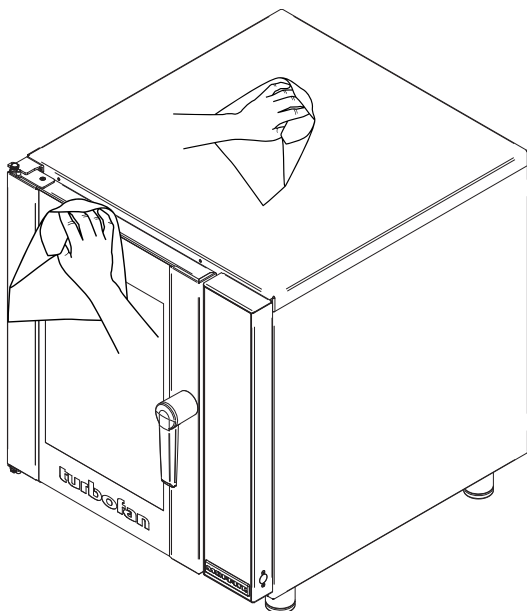

Cleaning the chamber

Before cleaning the interior of the oven, remove the side racks and other removable components.

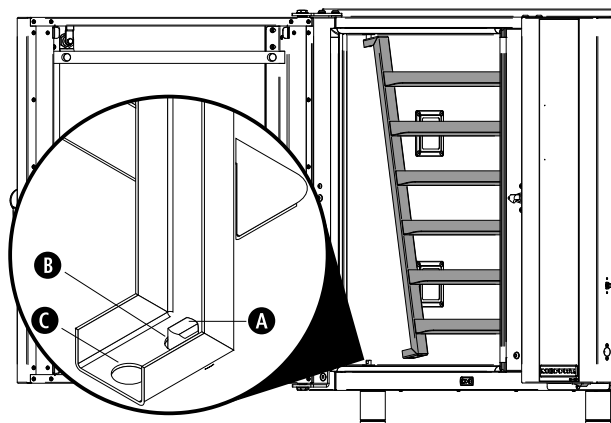

1. Lift up the rack off the bottom locating pins (A).
2. Pull the rack away from the chamber wall.
3. Lower the rack to clear the top locating pins and then remove the rack.
4. Lift up and unhook the right-hand side rack from the locating pegs at the front and rear of the oven.

Allow the oven interior to cool to approximately 50 °C (120 °F) before commencing cleaning.

1. Clean any build up of grease from the oven interior, using a soft bristled brush with a solution of hot water and a mild anti bacterial detergent.
 2. Clean the oven lamp. See [Cleaning the lamp below](#).
 3. Dry the oven thoroughly with a soft dry cloth.
- 💡 Clean the oven regularly with a good quality oven cleaner.

Once the oven interior is clean and dry, fit the oven racks back into the chamber.

The racks can be fitted to take 16 in. or 18 in. sized trays. Ensure that the racks are fitted correctly for the tray size.

- For 16 in. trays, fit the locating pin (A) into locating hole B.
- For 18 in trays fit the locating pin (A) into locating hole C.

To fit the racks back into the chamber:

1. Fit the top of the rack into the appropriate top locating pins.
2. Lower the bottom of the rack into the appropriate bottom locating pins.

Cleaning the lamp

1. Wash the glass lens with a soft sponge using warm water and a detergent solution.
2. Rinse with clean, warm water.
3. Dry the glass lens thoroughly with a dry cloth.

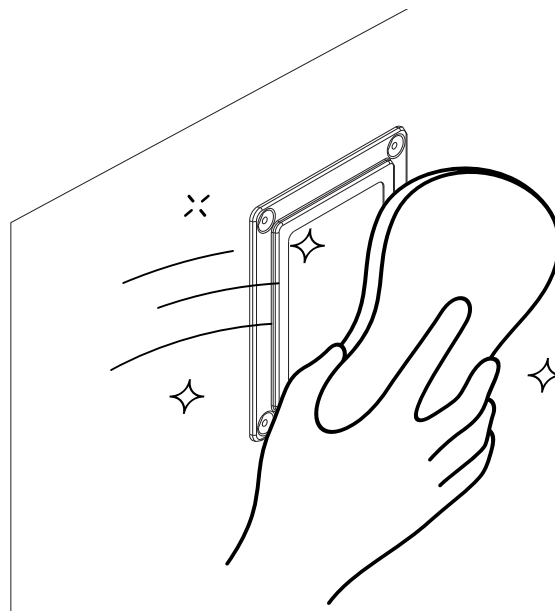

Changing the lamp light

- ⚠️ Oils from your skin may cause the halogen bulb to heat unevenly and reduce its lifespan. Always wear gloves or use a tissue when you handle the bulb.

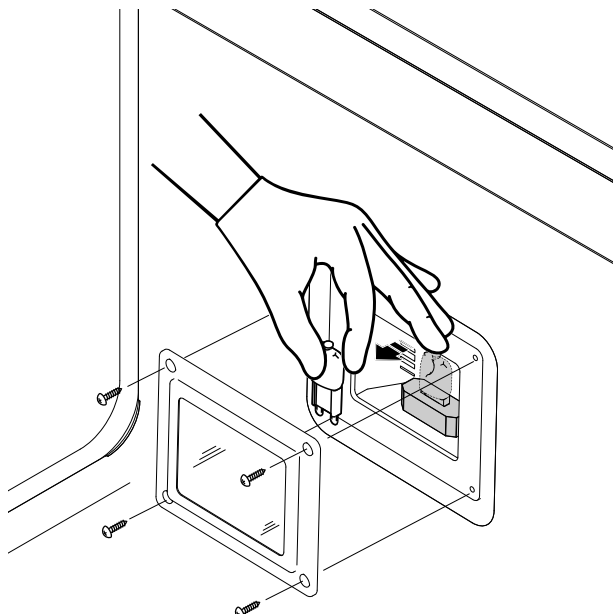

1. Remove the four screws that secure the lamp plate to the frame.
2. Carefully remove the lamp plate along with the glass lens.
3. Carefully grasp the bulb and pull it straight out of the socket.
4. Insert a new bulb and refit the lamp plate along with the glass lens.

Cleaning the door seal

1. Clean along and around the door seal using a mild detergent spray.

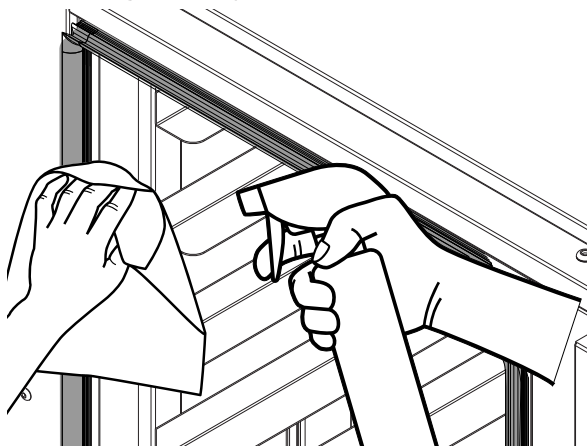

2. Wipe the door seal clean with a damp cloth.

Replacing the door seal

1. To remove the door seal, pull the one-piece seal forward to free the inner lip from the locating groove around the oven.

ⓘ Note the way the seal is fitted to the oven, with the lip facing inwards.

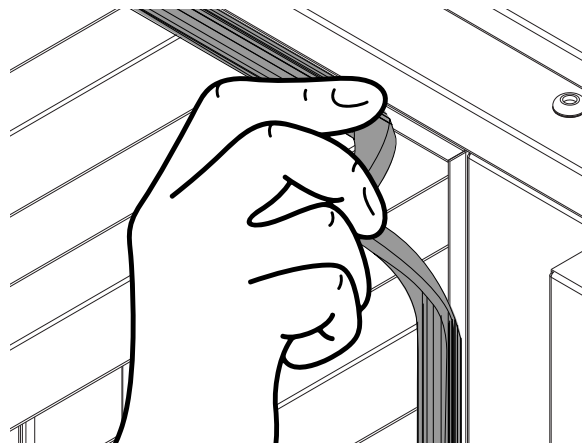

2. Check the door seal for wear and damage and replace it, if required.
3. Fit the door seal with the inner lip facing the oven chamber.
4. Press the door seal into the locating groove in the front face of the oven until the seal is properly located all around the oven.

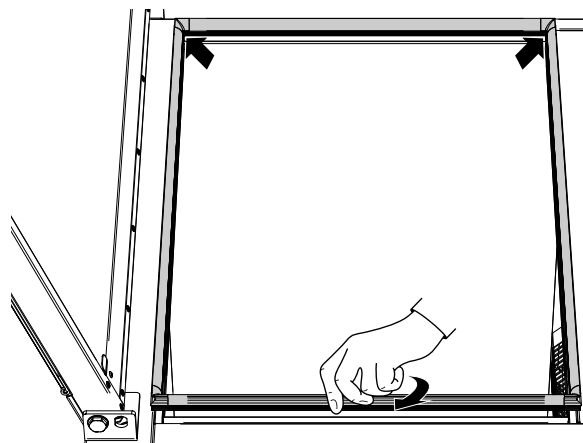

Cleaning the door

1. Ensure that the oven door is cool before cleaning the oven door glass.
2. Close the oven door.

3. With a screwdriver, coin, or other suitable tool, rotate the outer glass locks by a $\frac{1}{4}$ turn to release the outer glass and allow it to be hinged open for cleaning access.

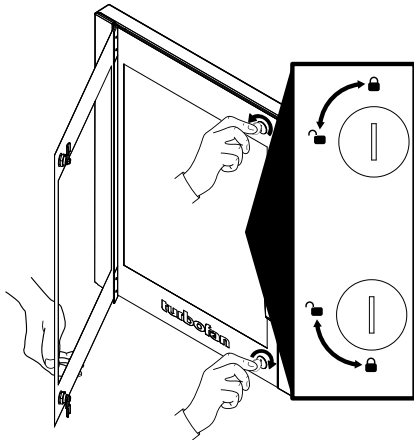

4. Clean both sides of the inner glass and the inner side of the outer door glass with a conventional glass cleaner.

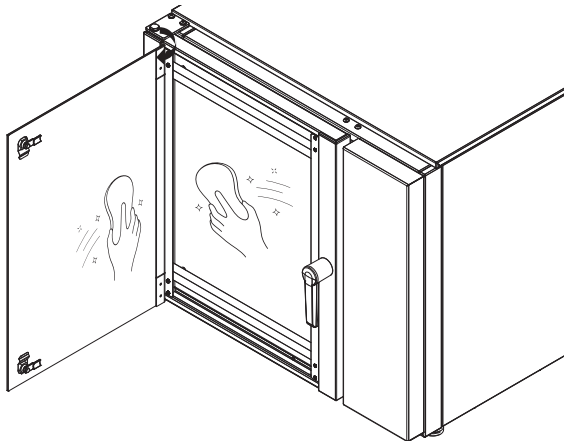

5. Dry the oven door thoroughly with a soft dry cloth.
6. Swing the inner glass back towards the outer door.
7. Close the outer glass and lock it securely.

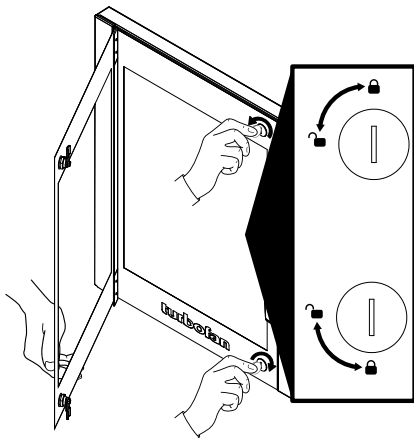

TROUBLESHOOTING

This section provides a reference to the more common problems that may occur during the operation of your oven. This fault finding guide is intended to help you correct and accurately diagnose problems with your oven.

⚡ When fault finding a problem, always use a process of elimination starting with the simplest solution and working through to the most complex. Never overlook the obvious.

Fault finding

Fault	Possible causes	Remedy
The oven does not operate.	The mains isolating switch, circuit breaker, or fuses are off at the power board.	Turn on the main isolating switch.
		Check the fuses at the power board.
	Over-temperature thermostat has tripped (no lights and no power to screen).	Call for service.
	Over-temperature thermostat is faulty.	Call for service.
	Heating element is faulty.	Call for service.
Controller operates but oven does not heat.	Controller is faulty.	Call for service.
	Door micro-switch is faulty.	See Error codes on page 30 .
	Heating contactor is faulty.	Call for service.
	Door is not fully closed.	Close the door. See <i>Door does not close fully</i> below.
The oven heats up but fan does not operate.	Fan motor is faulty.	Call for service.
	Fan or fan motor is obstructed.	Call for service.
	Controller is faulty.	Call for service.
	Fan contactor is faulty.	Call for service.
	Fan capacitor is faulty.	Call for service.
The oven does not steam.	Steam mode not selected.	Check the steam mode setting.
	Injector is nozzle blocked.	Clean the injector nozzle.
	Water solenoid faulty.	Call for service.
	Controller is faulty.	Call for service.
Door does not close fully.	The tray is blocking the door.	Correctly position the tray in the rack.
	Door is misaligned.	Re-align the door. See the Installation manual.
	Door seal obstruction.	Correctly install the door seal. See Maintenance tasks on page 25 .
The oven lamp does not illuminate.	Blown bulb (one bulb not working).	Replace the bulb. See Maintenance tasks on page 25 .
	Blown fuse (both bulbs not working).	Call for service.
Uneven cooking.	Too high a temperature selected.	Select a lower temperature.
	The oven or racks are not level.	Level the oven and the racks.
	Insufficient air space around trays or baking tins.	Ensure oven racks are spaced to allow air flow around baking on all shelves.
	The oven is overloaded with product.	Re-load the oven.
	The oven door is opened unnecessarily.	Ensure oven door remains closed during the baking process.
	The oven door seal is damaged or faulty.	Check the seal and replace it if damaged. See Maintenance tasks on

Fault	Possible causes	Remedy
	The vent is restricted.	page 25. Ensure that the oven vent is not blocked or shrouded.
Control panel display does not show core temperature probe connection indicators.	Core temperature probe is faulty.	Replace the core temperature probe.

Error codes

The following error messages appear on the display when there is a corresponding fault.

Error	Description	Possible cause	Remedy
Cavity Probe Error Call For Service	Oven temperature probe error.	The temperature probe is faulty.	Call for service.
		The connections on the oven control board are loose or faulty.	Call for service.
		The oven control board is faulty.	Call for service.
Cavity High Temperature Error Call For Service	Heating control circuit fault. The oven cavity temperature exceeds 640°F / 338°C.	The temperature probe is faulty.	Call for service.
		The temperature input on the control board faulty.	Call for service.
		The heating relay is stuck in the ON position.	
		The Heat output terminal on the control board is stuck in the ON position.	Call for service.
No Heat Error Call For Service	No temperature rise is detected within 15 minutes.	The temperature probe is faulty.	Call for service.
		The temperature input on the control board faulty.	Call for service.
		The heating relay is faulty.	
		The oven control board is faulty.	Call for service.
I/O Error Call For Service	The controller cannot read the SD card.	The SD card connection is poor.	Call For Service.
		The oven control board is faulty.	Call for service.
Fan Error Call For Service	The fan overheating input is active.	The cooling fan is faulty.	Call For Service.
		The cooling fan is obstructed.	Call For Service.
		The cooling fans vents are blocked.	Call For Service.
		The oven is too close to a heat source.	Increase the oven's proximity to the heat source.
		The capacitor is faulty.	Call for service.
		Bad connection to fan the overheat input on the controller.	Call For Service.
		The motor is faulty.	Call for service.
		The supply input to the controller is faulty.	Call For Service.
Core Probe Error Call For Service	Core temperature probe fault.	The core temperature probe socket connection is poor.	Ensure that the core temperature probe socket is clean and free from contamination. Ensure that the terminals and connectors on the probe and socket are in good condition.
		The core temperature probe is faulty.	Replace the core temperature probe.

		The oven control board is faulty.	Call for service.
Configuration Files Invalid Attempting To Restore Call For Service	Controller files error.	Controller configuration Error.	Call For Service.
		The SD card connection is poor.	Call For Service.
		The oven control board is faulty.	Call for service.
Hood is not running Check hood	VH hood enabled, but not fitted or connected correctly.	The VH hood is not plugged in or not switched on.	Ensure that the hood is correctly connected and switched on.
		The connection between the oven and hood is faulty.	Check all the connections between the oven and hood. Call for service.
		The oven controller is programmed incorrectly.	Call for service.
		The VH hood is faulty.	Call for service.
		The oven control board is faulty.	Call for service.

CONTROLLER RANGES AND DEFAULTS

Manager configuration mode

Screen	Parameter	Range	Default
1	MANUAL MODE	–	–
	COPY RECIPES TO USB	–	–
	COPY RECIPES FROM USB	–	–
	RECIPE IMAGE MAINTENANCE		
	COPY IMAGES FROM USB	–	–
	DELETE RECIPE IMAGES	–	–
2	BUZZER VOLUME	0-5	2
	COOK DONE BEEP	ON OFF	ON
	KEY PRESS FEEDBACK	ON OFF	ON
	READY BEEP	ON OFF	ON
3	PREHEAT OPTIONS	50 °C-260 °C 120 °F-500 °F	145 °C 293 °F
	AUTO START OPTIONS		
	Autostart temperature	50 °C-260 °C 120 °F-500 °F	OFF
	Autostart time	12.59 hrs/mins, AM/PM	OFF
	SETBACK OPTIONS		
	Setback time	66 °C-204 °C 150 °F-400 °F	OFF
	Setback temperature	2 mins - 1 hr	
	AUTO COOL TEMPERATURE	0 °C-260 °C 0 °F-500 °F	50 °C 122 °F
4	COOK COOLDOWN	ON OFF	OFF
	RECIPE RUNTIME CHANGES	ON OFF	ON
	SAVE MANUAL RUNTIME CHANGES	ON OFF	ON
	SAVE RECIPE RUNTIME CHANGES	ON OFF	OFF
5	TIME ENTRY	01:00 to 12:59 hrs/mins	
	DATE ENTRY	Day / Month / Year	
	SELECT LANGUAGE SCREEN		ENGLISH
	TEMPERATURE UNITS	°C °F	°C
6	BRIGHTNESS	0-5	5
	AUTO DIM SETTINGS		
	TIME SETTING	0 - 60 minutes	10 mins
	BRIGHTNESS SETTING	0 - 100% (in increments of 25%)	25%
	PASSCODE MAINTENANCE		
	RECIPE PASSCODE	0000 - 9999	–
	MANAGER PASSCODE	0000 - 9999	4500
	RE-CALIBRATE TOUCH SCREEN		

TURBOFAN CUSTOMER CARE

New Zealand

Moffat Limited
www.moffat.co.nz
Tel: +64 (3) 983 6600
Fax: +64 (3) 983 6660
Email: sales@moffat.co.nz

Australia

Moffat Pty Ltd
www.moffat.com.au
Tel: +61 (03) 9518 3888
Service: 1300 264 217
Fax: +61 (03) 9518 3833
Email: vsales@moffat.com.au

Canada

Serve Canada
www.servecanada.com
Sales: 800 551 8795
Service: 800 263 1455
Email: info@servecanada.com

United Kingdom

Blue Seal Limited
www.blue-seal.co.uk
Tel: 0121 327 5575
Service: 0121 332 6647
Fax: 0121 327 9711
Email: sales@blue-seal.co.uk

International

Moffat Limited
www.moffat.com
Tel: +64 (3) 983 6600
Fax: +64 (3) 983 6660
Email: export@moffat.co.nz

United States

Moffat Inc
www.moffat.com
Tel: 1 800 551 8795
Fax: 336 661 9546
Email: sales@moffat.com

an Ali Group Company



the spirit of excellence